

VACUUM CLEANER

INSTRUCTION MANUAL

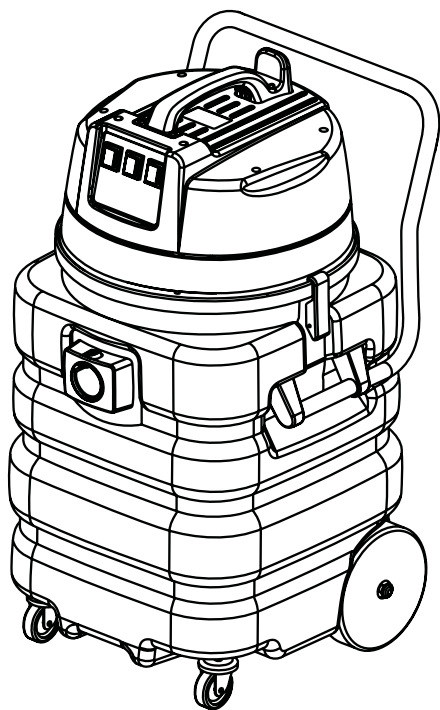

ZD98 WET&DRY VACUUM CLEANER



1.Characteristics

1. Industrial vacuum cleaner for wet and dry
2. With double wheels motor, motors work at the same time with stronger suction
3. Jacks on the base, easy for depositing accessories
4. With special and good-looking design, Suitable for hotel, office, factory etc.
5. Stainless steel barrel for permanent use

2.Choose suitable accessories for different occasions.

*Wet floor nozzle for floor, carpet etc.



*Bristle for window, table etc.

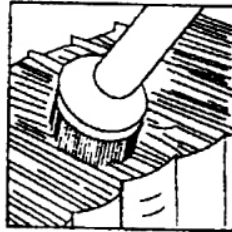

*Crevice nozzle for crevice, corner etc.

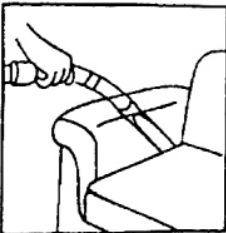

3.Safety Instruction

1. Check before operation that the power voltage is the same as the specification on the rating

2. Do not use machine in the combustible and explosive place in case the motor spark cause fire.

3. Do not jam the air inlet mouth, in case causing high temperature rise and damage the motor.

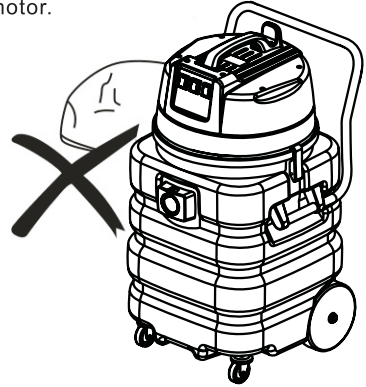

4. Do not pick up combustible and explosive objects such as glowing cigarette, gasoline etc. Do not pick up sharp objects.

*Do not pick up sharp objects.



* Do not pick up objects which easily attach on the filter such as calcareousness powder, gesso and graphite powder that will block the ventilation and damage motor.

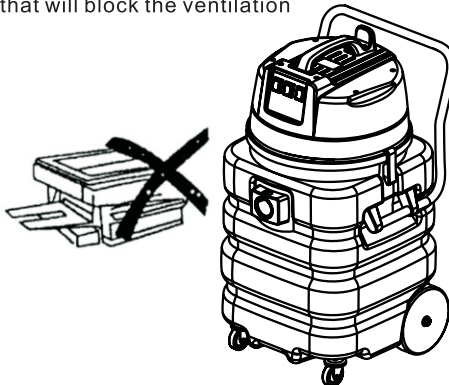

5. Warning: If water out from air outlet mouth, do not overturn the machine when repairing in case water goes into the motor and cause damage
Do not use this machine as pump in case damaging the motor.
6. Turn off the machine and remove the plug each time after using or when repairing.
7. keep machine away from strong sunlight and high temperature place in case plastic distorting.
8. Do not wrest, tramp, or haul hose in case make it damaged.

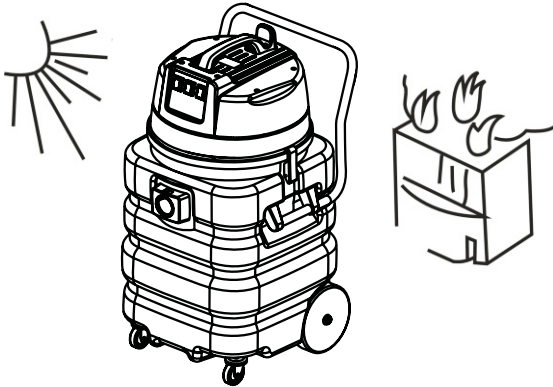

9. Do not immerses water into the barrel cap or wash the barrel cap by water in case water goes into the electriferous parts and cause person injury. The correct way should be: Immerses the dishcloth then tweak to be dry. Wipe the dirty part gently
10. Do not use by children or not mature person.
11. When clearing the stair, do use extra protection in case machine falls off when moving the hose.

4. Use Instruction

1. Connection

Insert the hose connector into the air inlet mouth as picture shows, make sure the connector is tightly fastened.

Connect all the accessories as picture shows.

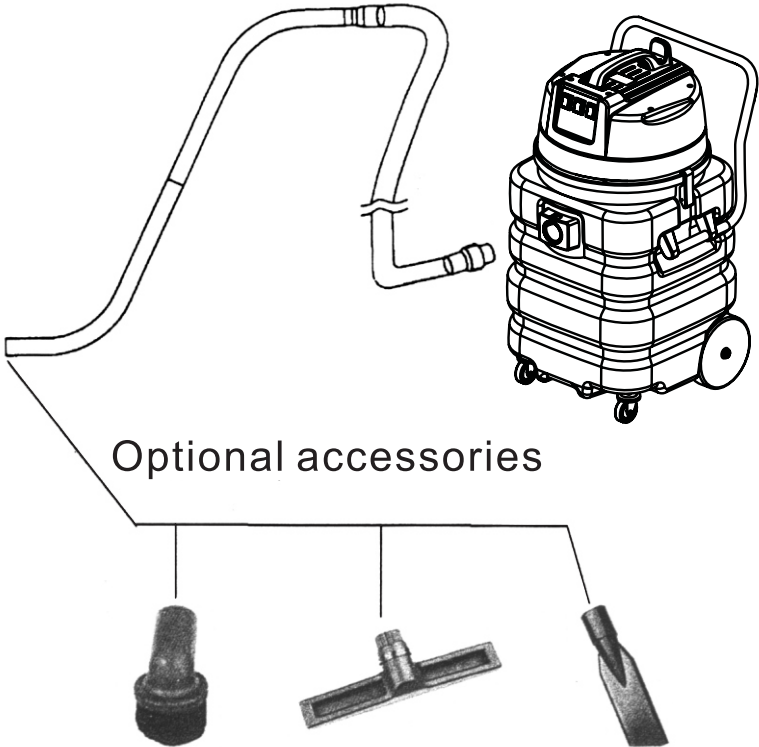

2. Check whether the dust filter is put in before operation.
3. Take away all the things in barrel including the dust filter before the wet use.
4. Put the power cordless at the right back of Connector terminal when use the machine.
5. Insert the plug into the supply socket.
6. Press switch button, the machine begin to work.

5. Protection Device

Special instruction concerning protective device

1. When the water in the barrel is full, the device begins to work. The suction power will vanish at this moment. The machine will make a noise which indicates the motor is running at a high speed. Under this circumstance, you should cut off the electricity, clean out the water, then equip the machine and turn it on, it will begin to work normally.
2. Only connect to a proper 220- 240 volt. 50 Hz socket.
3. If the supply cord is damaged, it must be replaced by the manufacturer or its service agent to a similarly qualified person in order to avoid a hazard.
4. This appliance is not intended for use by persons (including children) with reduced physical, sensory or mental capabilities, or lack of experience and knowledge, unless they have been given supervision or instruction or instruction concerning use of the appliance by a person responsible for their safety.
5. Children should be supervised to ensure that they do not play with the appliance.
6. The plug must be removed from the socket before cleaning or maintaining the appliance.

6. Correct Disposal of this product

This marking indicates that this product should not be disposed with other household wastes throughout the EU. To prevent possible harm to the environment or human health from uncontrolled waste disposal, recycle it responsibly to promote the sustainable reuse of material resources. To return your used device, please use the return and collection systems or contact the retailer where the product was purchased. They can take this product for environmental safe recycling.

7. Warranty Information

The manufacturer provides warranty in accordance with the legislation of the customer 's own Country of residence, with a minimum of 1 year (Germany: 2 years), starting from the date on which the appliance is sold to the end user.

The warranty only covers defects in material or workmanship.

The repairs under warranty may only be carried out by an authorized service centre. When making a claim under the warranty, the original bill of purchase (with purchase date) must be submitted.

The warranty will not apply in cases of.

- Normal wear and tear
- Incorrect use, e.g. overloading of the appliance, use of non-approved accessories
- Use of force, damage caused by external influences
- Damage caused by non-observance of the user manual, e.g. connection to an unsuitable mains supply or non-compliance with the installation instructions
- Partially or completely dismantled appliances

8.Maintenance

1. Barrel Cleaning

After working or when the barrel is full of dust which cause suction decreases considerably, the plug must be removed from the socket-outlet before cleaning or maintaining the appliance.

- 1) Unfasten the locking knob, lift up the top cover.
- 2) Take off the filter bag, clean the dust away in the dust barrel.
- 3) Install the filter bag back and place the top cover.

(The position of the power switch and air inlet mouth should be in the same direction.)

2.Filter bag cleaning

The filter bag should be washed by clean and warm water when it was covered with dust. If necessary, you can use litmusless scour to wash.

- 1) Take off the filter
- 2) Wash
- 3) Dry

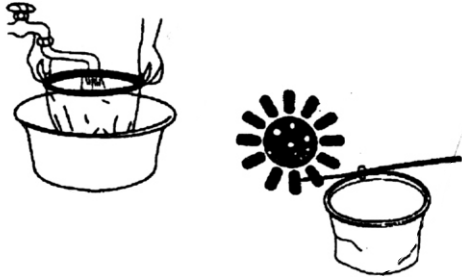

9. WET/DRY VACUUM CLEANER

Technique Parameter

Type	ZD98-2B/ZD98-3B
Power	2000W/3000W
Cooling system	Recycle
Vacuum degree	20kpa-21kpa
Capacity	90L
Tank diameter	420mm
Function	Wet/Dry
Voltage	220-240V
Length of cable	5m

Accessories

1	Suction hose
2	Short Connector
3	Long Connector
4	Metal Tube
5	Dry floor nozzle
6	Wet floor nozzle
7	Crevice tool
8	Dust brush

